

12 mm

## Stratificati HPL

HPL Compact • Compact HPL • Compacto HPL



STATUARIO • LAMICOLOR  
5547 • PLAMKY/SHIKI

## Caratteristiche

Features • Caractéristiques • Características

- **ESTERNO / FRONT / RECTO / CARA SUPERIOR:**  
Decoro HPL laminato  
HPL Decoration Laminate  
Stratifié Décor HPL  
Decoración laminado HPL
- **INTERNO / REAR / VERSO / CONTRACARA:**  
Decoro HPL laminato  
HPL Decoration Laminate  
Stratifié Décor HPL  
Decoración laminado HPL

# Finiture

Finishes • Finitions • Acabados

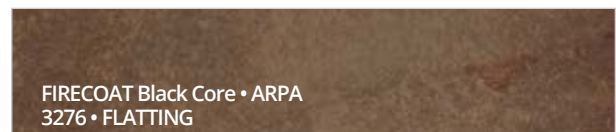
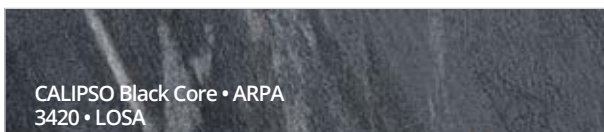
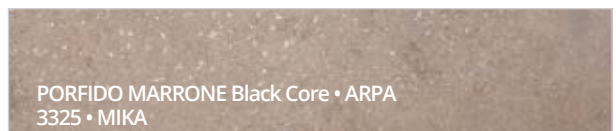
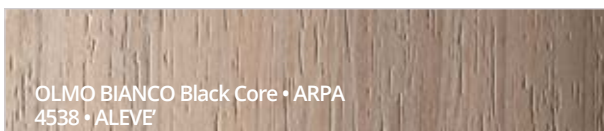
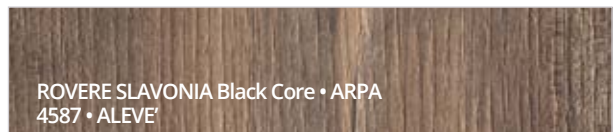
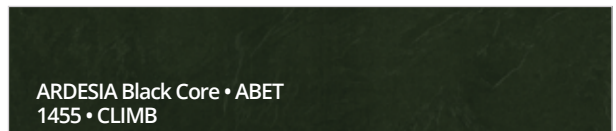
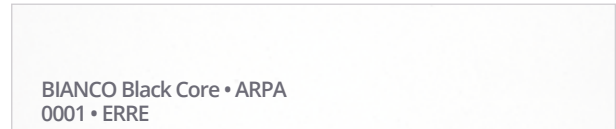
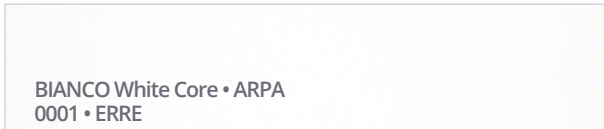
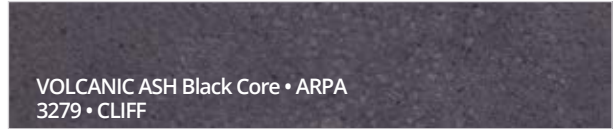
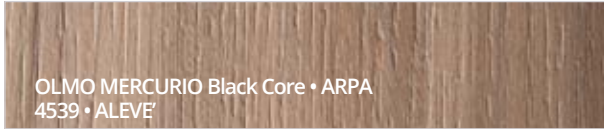

12 mm

## Stratificati HPL

HPL Compact • Compact HPL • Compacto HPL



ROVERE SLAVONIA • ARPA  
4587 • ALEVE'

## Piani cucina

Worktops • Plans de travail et jambages • Encimeras y laterales

### Stratificato SP. 12 mm

Compact TH. 12 mm.

Compact EP. 12 mm.

Compacto ESP. 12 mm.

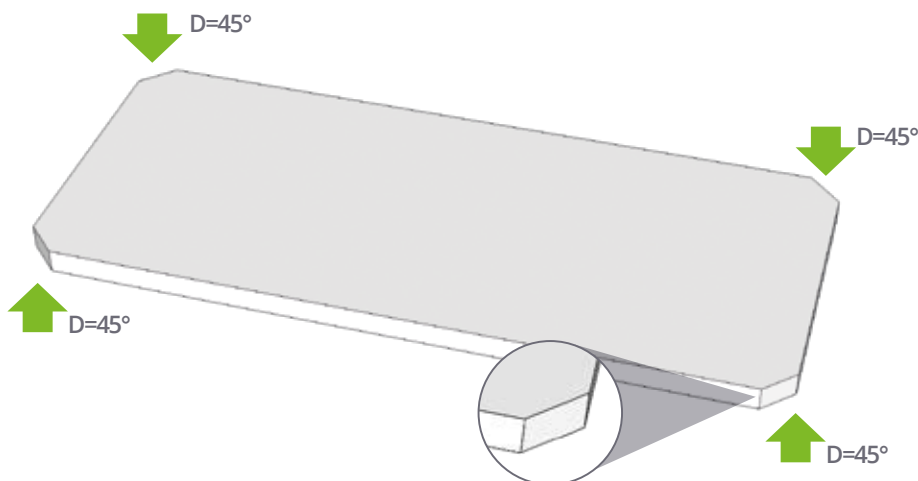

- Piani di lavoro e fianchi
- Stratificato Interno = Esterno
- Profili bisellati
- Dimensione MIN. lavorabile 240 x 560
- Dimensione MAX. lavorabile 1280 x 4150
- Worktop and column
- Compact double-faced
- Machined profiles
- Minimum machinable dimensions 240 x 560
- Maximum machinable dimensions 1280 x 4150
- Plan de travail et jambages
- Compact double face
- Chants usinés • Dimension mini usinable 240 x 560
- Dimension maxi usinable 1280 x 4150
- Planos de trabajo y laterales
- Compacto doble cara
- Cantos mecanizados
- Dimensión mín. mecanizable 240 x 560
- Dimensión máx. mecanizable 1.280 x 4.150

P/R	W	U. M.
PTCH40	240-400	M/L.
PTCH64	401-640	M/L.
PTCH78	641-780	M/L.
PTCH90	781-900	M/L.
PTCH126	901-1280	M/L.

**I profili bisellati non hanno nessun costo extra, indicarli nel disegno tecnico.**

Machined profiles are performed without extra charge, please indicate them in your diagram.

Les chants usinés sont effectués sans surcharge de prix, merci de les indiquer sur votre schéma.

Los cantos mecanizados se efectúan sin recargo en el precio, por favor indíquelos en el esquema.

 **Cuore nero**  
Black Core • Coeur Noir • Núcleo negro

 **Cuore bianco**  
White Core • Coeur Blanc • Núcleo blanco

**P/R = Referenza Prodotto** / Product Reference / Référence Produit / Referencia Producto

**W = Profondità** / Width / Profondeur / Fondo

**U.M. = Unità di Misura** / Unit of Measure / Unité de Mesure / Unidad de Medida

---



## Lavorazioni speciali piani di lavoro

Worktop machining options

Options d'usinage plans de travail

Opciones de mecanización de encimeras

---

### Stratificati HPL

HPL Compact

Compact HPL

Compacto HPL

12 mm

---

### Stratificati FENIX

FENIX Compact

Compact FENIX

Compacto FENIX

12 mm

**PDC**

**Taglio Fem/Dx**  
R/Fem cut  
Déc. Plat D.  
Corte Dcho/Hembra +  
ranurado yensablaje con  
galletas

**BGC**

**Taglio Mas/Sx**  
L/Male cut  
Déc. Bout G.  
Corte Izdo/Macho + ra-  
nurado yensablaje con  
galletas

**BDC**

**Taglio Mas/Dx**  
R/Male cut  
Déc. Bout D.  
Corte Dcho/Macho +  
ranurado yensablaje con  
galletas

**PGC**

**Taglio Fem/Sx**  
L/Fem cut  
Déc. Plat G.  
Corte Izdo/Hembra +  
ranurado yensablaje con  
galletas

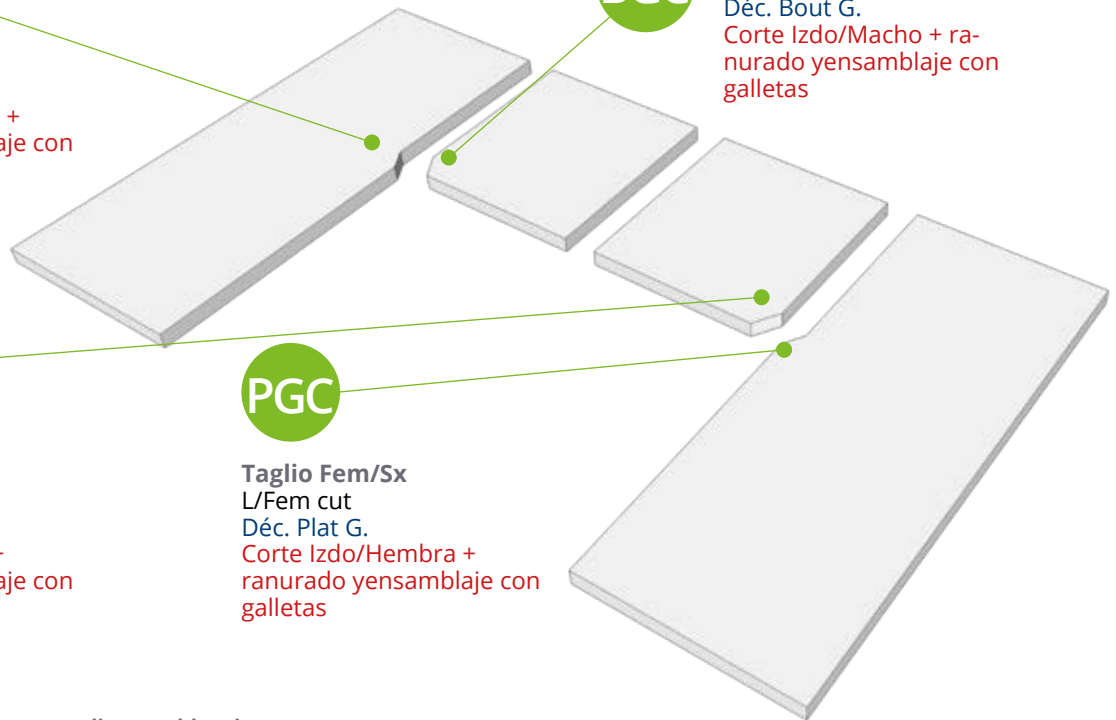

**Non necessita di ferramenta di assemblaggio**

Without assembly hardware / Sans ferrures d'assemblage / No hace falta herraje de ensamblaje

**U.M. Unit**

**Taglio Post. Sx**  
Rear L Cut  
Déc. Arrière G.  
Corte esquina posterior Izdo

**XDC**

**XBC**

**Taglio Post. Dx**  
Rear R Cut  
Déc. Arrière D.  
Corte esquina posterior Dcho

**XCC**

**Taglio Front. Sx**  
Front L Cut  
Déc. Avant G.  
Corte esquina delantero Izdo

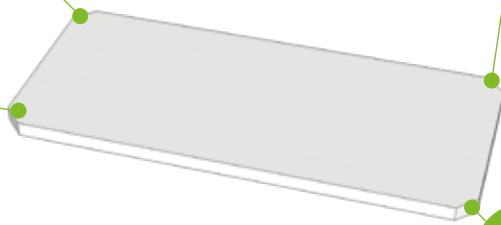

**XAC**

**Taglio Front. Dx**  
Front R Cut  
Déc. Avant D.  
Corte esquina delantero Dcho

**U.M. Unit**

**Arrot. Post. Sx**  
Rear L Round Cut  
Coin arrondi arrière G.  
Redondeo posterior Izdo

**FDC**

**FBC**

**Arrot. Post. Dx**  
Rear R Round Cut  
Coin arrondi arrière D.  
Redondeo posterior Dcho

**FCC**

**Arrot. Front. Sx**  
Front L Round Cut  
Coin arrondi Avant G.  
Redondeo delantero Izdor

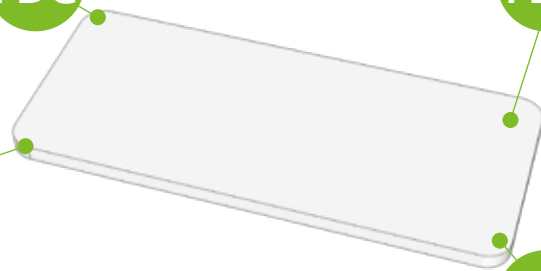

**FAC**

**Arrot. Front. Dx**  
Front R Round Cut  
Coin arrondi avant D.  
Redondeo delantero Dcho

**HPL Compact • HPL Compact • Compact HPL • Compacto HPL**

Raggio minimo / Minimum radius / Rayon min / Radio mínimo: 30mm

**FENIX Compact • FENIX Compact • Compact FENIX • Compacto FENIX**

Raggio minimo / Minimum radius / Rayon min / Radio mínimo: 10mm

**U.M. Unit**

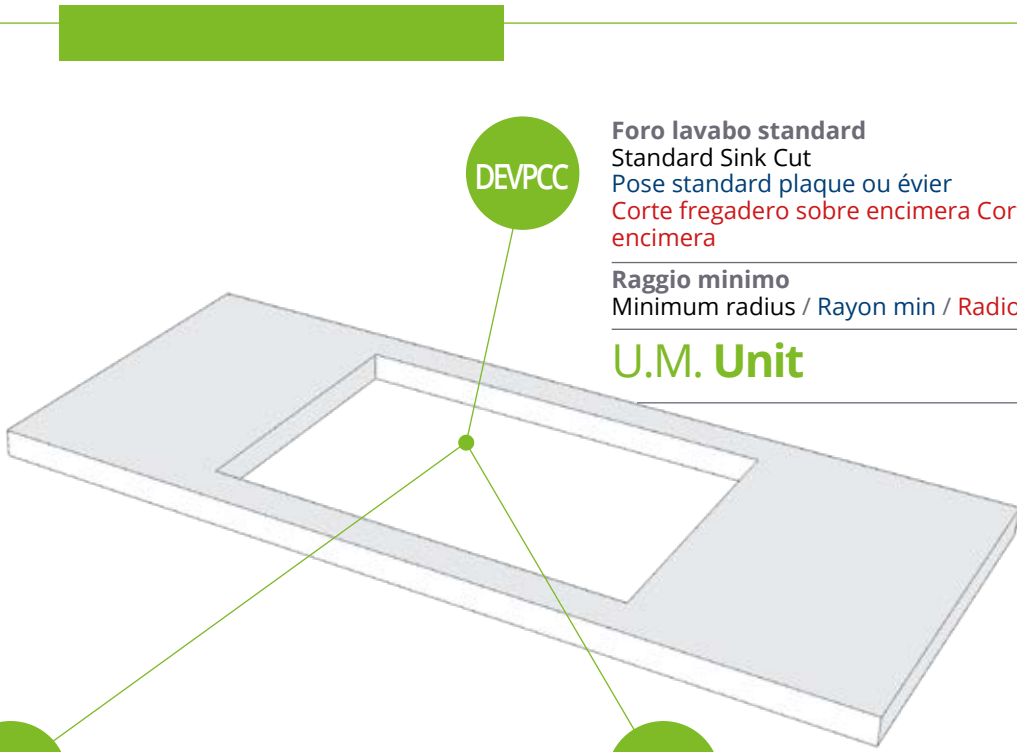

DEVPCC

**Foro lavabo standard**

Standard Sink Cut

Pose standard plaque ou évier

Corte fregadero sobre encimera Corte placa sobre encimera

**Raggio minimo**

Minimum radius / Rayon min / Radio mínimo: 7,5mm

**U.M. Unit**



DEVPOLC

**Foro lavello sottopiano**

Undermount Sink Cut

Pose évier par dessous

Corte fregadero bajo encimera + canto pulido

**Raggio minimo**

Minimum radius / Rayon min / Radio mínimo: 10mm

**U.M. Unit**



DEVPCFC

**Foro lavello filo top**

Recessed Sink Cut

Pose à fleur plaque ou évier

Corte fregadero enrasado Corte placa enrasada

**Raggio minimo**

Minimum radius / Rayon min / Radio mínimo: 7,5mm

**U.M. Unit**

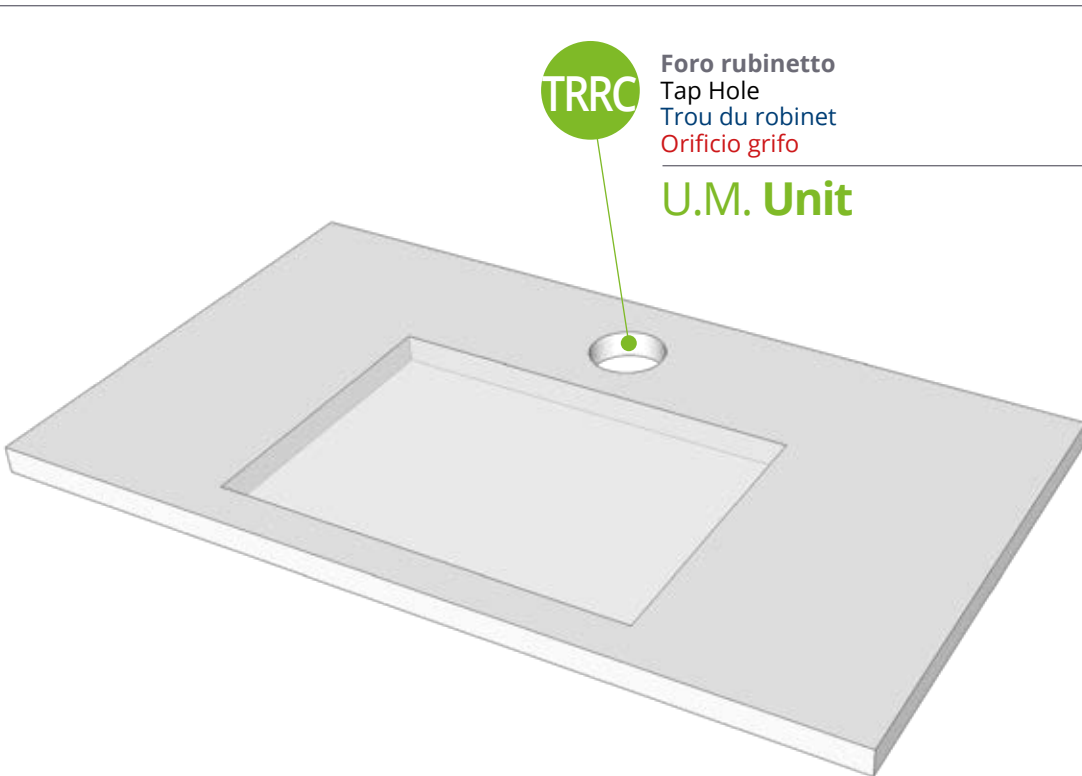

TRRC

**Foro rubinetto**

Tap Hole

Trou du robinet

Orificio grifo

**U.M. Unit**

**U.M. = Unità di Misura / Unit of Measure / Unité de Mesure / Unidad de Medida**

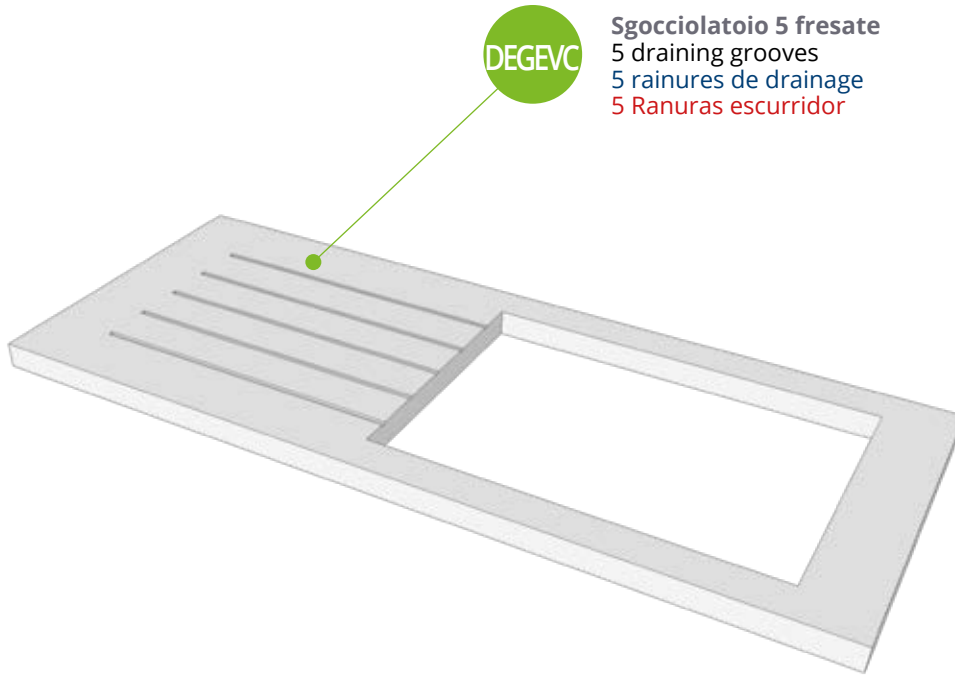

DEGEVC

**Sgocciolatoio 5 fresate**  
 5 draining grooves  
 5 rainures de drainage  
 5 Ranuras escurridor

**Indicare numero e posizione delle fresate**  
 Number and positions of adjustable grooves  
 Nombre et positions de rainures modifiables  
 Indicar el número y posición de las ranuras

**U.M. Unit**

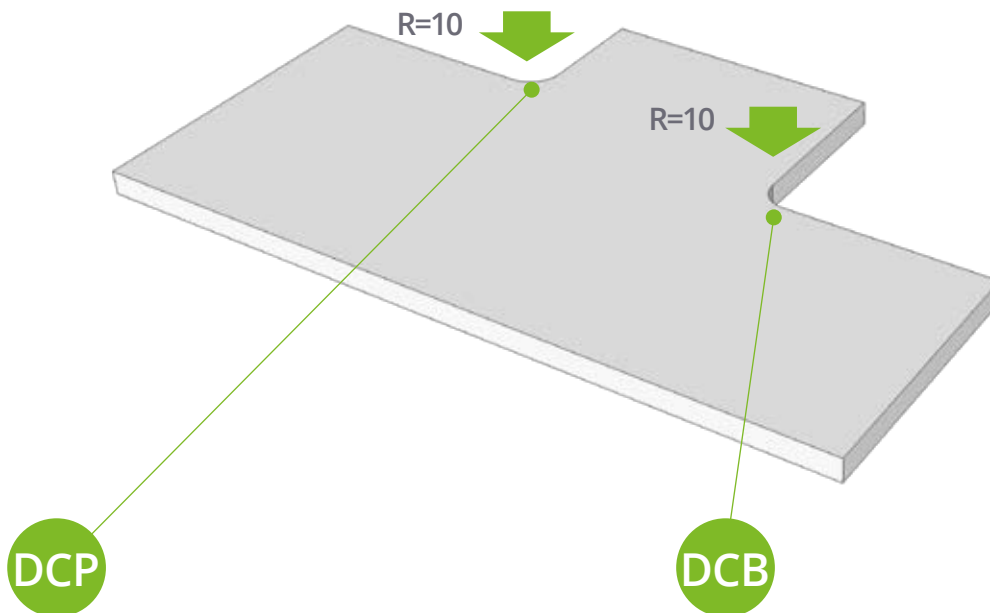

DCP

**Taglio Bisellato R=10**  
 Polish Cut R=10  
 Découpe chant poli R=10  
 Corte canto pulido R=10

**U.M. Unit**

DCB

**Taglio grezzo R=10**  
 Rough Cut R=10  
 Chant brut R=10  
 Corte canto bruto R=10

**U.M. Unit**



# Schienali in stratificato HPL

Wall panels Compact HPL

Crédences Compact HPL

Frontal de pared Compacto HPL

**Sp. 12 mm**

Th. 12 mm • EP. 12 mm. • ESP. 12 mm

**Minimo fatturabile 0,15 m<sup>2</sup>**

Minimum order 0,15 m<sup>2</sup> / Minimum de facturation 0,15 m<sup>2</sup> / Facturación mínima 0,15 m<sup>2</sup>

- Stratificato Interno = Esterno
- Compact double-faced
- Compact double face
- Compacto doble cara



● **Cuore nero**  
Black Core • Coeur Noir • Núcleo negro

○ **Cuore bianco**  
White Core • Coeur Blanc • Núcleo blanco

**I profili bisellati non hanno nessun costo extra, indicarli nel disegno tecnico.**

Machined profiles are performed without extra charge, please indicate them in your diagram.

Les chants usinés sont effectués sans surcharge de prix, merci de les indiquer sur votre schéma.

Los cantos mecanizados se efectúan sin recargo en el precio, por favor indíquelos en el esquema.

P/R	H	U. M.
PCCH24	50-240	M/L.
PCCH30	241-300	M/L.
PCCH40	301-400	M/L.
PCCH64	401-640	M/L.
PCCH78	641-780	M/L.
PCCH90	781-900	M/L.
PCCH126	901-1280	M/L.

Nome • Name • Designation • Denominación	Altezza • Height • Haut. • Alto	Lunghezza • Length • Long. • Ancho
<b>Schienali dim. min. bisellatura 3 lati</b> Wall panels min. dim. for 3 machined sides Credence dim. min. 3 chants usinés <b>Frontal de pared dimension min. 3 cantos pulidos</b>	50 mm.	560 mm.
<b>Schienali dim. min. bisellatura 4 lati</b> Wall panels min. dim. for 4 machined sides Credence dim. min. 4 chants usinés <b>Frontal de pared dimension min. 4 cantos pulidos</b>	240 mm.	560 mm.
<b>Schienali dim. max. bisellatura 4 lati</b> Wall panels max. dim. for 4 machined sides Credence dim. max. 4 chants usinés <b>Frontal de pared dimension max. 4 cantos pulidos</b>	1280 mm.	4180 mm.

**P/R = Referenza Prodotto** / Product Reference / Référence Produit / Referencia Producto

**H = Altezza** / Height / Hauteur / Alto

**U.M. = Unità di Misura** / Unit of Measure / Unité de Mesure / Unidad de Medida



**Topstar S.p.A.**  
Via dell'industria 2 - 61024 Mombaroccio (PU)  
Tel. +39 0721 471 222 / 223 - Fax. +39 0721 471 224  
[info@topstarpostforming.com](mailto:info@topstarpostforming.com)