

13-19-39-59 mm

## Laminati HPL

HPL Laminate • Stratifié HPL • Laminado HPL



STATUARIO • LAMICOLOR  
5547 • PLAMKY/SHIKI

ROVERE SLAVONIA • ARPA  
4587 • ALEVE

## Caratteristiche

Features • Caractéristiques • Características

- **SUPPORTO / SUPPORT / SUPPORT / SOPORTE:**  
**Pannello in truciolare idrofugo P3 qualità EPF-S SP. 12-18-38-58 (\*eccetto spessore 12mm)**  
Waterproof\* chipboard panel P3 quality EPF-S TH. 12-18-38-58 (\*except thickness 12mm)  
Panneau de particule Hydrofuge\* P3 qualité EPF-S EP. 12-18-38-58 (\*sauf épaisseur 12mm)  
Tablero de partículas hidrófugo\* P3 calidad EPF-S ESP. 12-18-38-58 (\*salvo espesor 12 mm)
- **LAMINATO SUPERIORE / FRONT LAMINATE / STRATIFIÉ RECTO / LAMINADO CARA SUPERIOR:**  
**Laminato decorativo HPL**  
HPL Decoration Laminate / Stratifié Décor HPL / Decoración laminado HPL
- **LAMINATO INFERIORE / REAR LAMINATE / STRATIFIÉ VERSO / LAMINADO CONTRACARA:**  
**Controilanciante bianco**  
White Counterbalance Laminate / Stratifié Blanc de contrebilancement / Laminado blanco de contracara
- **PROFILO / PROFILE / CHANT / CANTO:**  
**ABS Spessore (0.6 a 1 a seconda del decoro)**  
ABS Thickness (0.6 to 1 depending on colours)  
ABS Épaisseur (0.6 à 1 selon couleurs)  
Espesor ABS (0,6 a 1 según colores)

# Finiture

Finishes • Finitions • Acabados

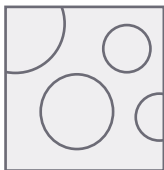

## Fantasia

Fantasy • Les Fantaisies • Las Fantasías



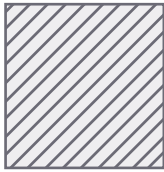

## Metallo (Lunghezza massima 3050)

Metal (Maximum length 3050)

Les métaux (Longueur maximum 3050)

Los metales (Longitud máxima 3.050)

ALLUMINIO • ABET  
0873 • SATINATO

MAGNETIC NERO • ABET  
421 • PAPIER

Disponibile solo per superfici verticali: schienali

Available for vertical surfaces only: wall panels

Disponible uniquement pour les surfaces verticales: crédences

Disponibile únicamente para las superficies verticales: frontal de pared



## Tinte unite

Solid colours • Les unis • Los solidos

BIANCO • ABET  
0410 • CLIMB



NERO • ABET  
0421 • CLIMB

GRIGIO ALPACA • ABET  
0869 • CLIMB

BRUNO VULCANO • ABET  
0897 • CLIMB

BIANCO • ARPA  
0028 • LUCIDA



BIANCO DECO' • ARPA  
0249 • ERRE

ANTRACITE • SAVIOLA  
797 • QZ



BIANCO LUNA • LAMICOLOR  
0751 • PLAMKY

GRIGIO FRISIA • LAMICOLOR  
1366 • PLAMKY



GRIGIO PLUTONE • LAMICOLOR  
1398 • PLAMKY







## Legni

Woods • Les bois • Las maderas

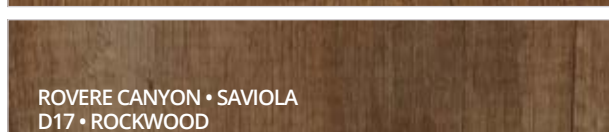
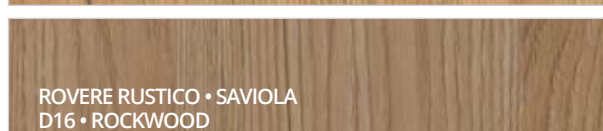
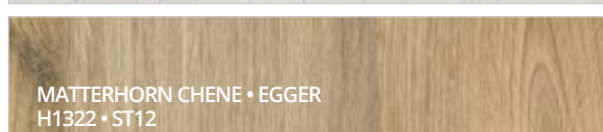
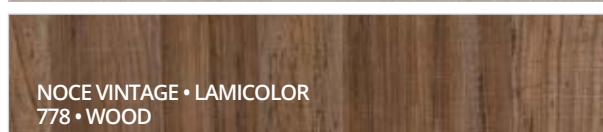
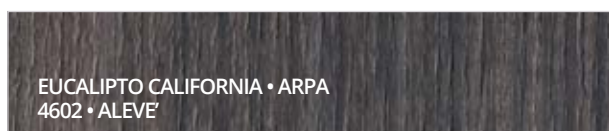
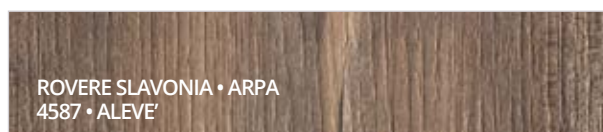
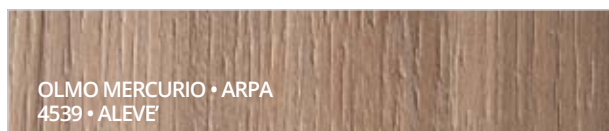
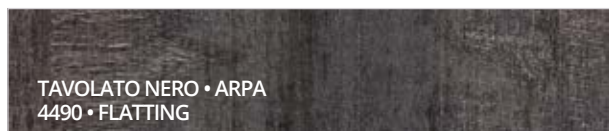

**Poro sincronizzato**  
Synchronised pores • Pores synchronisés  
Poro sincronizado



NEW



NEW



Decorativo disponibile in sp. 59mm

59mm decorations available • Décors disponibles en 59mm • Decoraciones disponibles en 59 mm

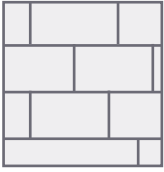

## Pietre

Stones • Les pierres • Las piedras

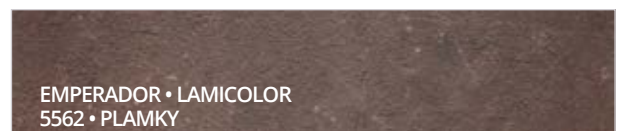
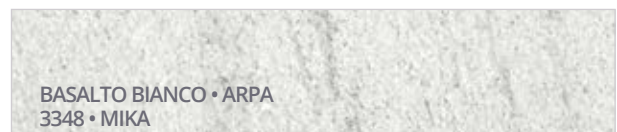
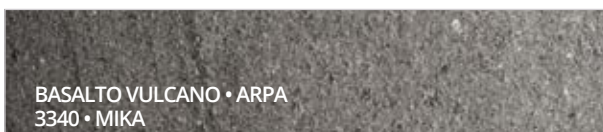
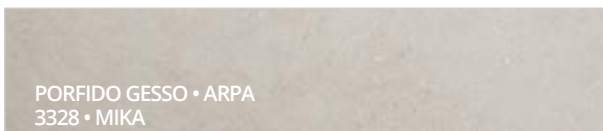
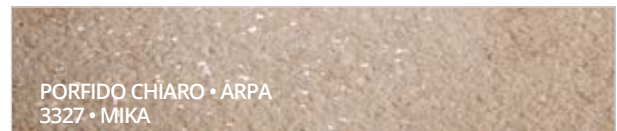
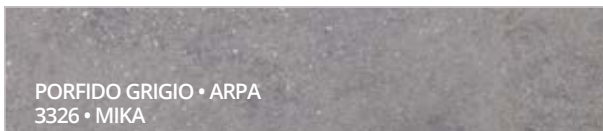
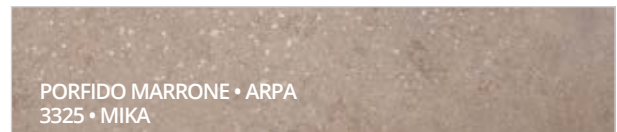
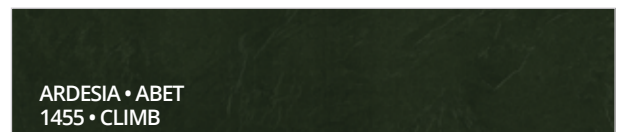



MUNE' GREY • ARPA  
3410 • LOSA



LUSERNA NERO • ARPA  
3366 • LUNA NEW



EVORA • LAMICOLOR  
5551 • PLAMKY



BOTTICINO • LAMICOLOR  
5555 • PLAMKY



EMERALD • LAMICOLOR  
5558 • PLAMKY

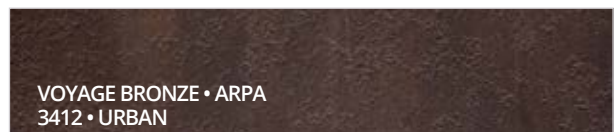

VOYAGE BRONZE • ARPA  
3412 • URBAN



VOYAGE SILVER • ARPA  
3413 • URBAN



CALIPSO • ARPA  
3420 • LOSA



CUMA DARK • ARPA  
3415 • LUNA NEW



PULPIS DARK • ARPA  
3446 • KER



PULPIS LIGHT • ARPA  
3447 • KER



YULE GREY • ARPA  
3448 • KER



YULE WHITE • ARPA  
3449 • KER



MARMO NERO • PURICELLI  
6133 • AR



Decorativo disponibile in sp. 59mm

59mm decorations available • Décors disponibles en 59mm • Decoraciones disponibles en 59 mm



13-19-39-59 mm

## Laminati HPL

HPL Laminate • Stratifié HPL • Laminado HPL



YULE WHITE • ARPA  
3449 • KER

## Piani di lavoro e fianchi

Worktops and side panels • Plans de travail, plans de travail  
double-face et jambages • Encimeras de trabajo una cara, doble cara y  
laterales

### Sp. 12-18-38-58 mm + Laminato

Th. 12-18-38-58 mm + Laminate

Ép. 12-18-38-58 mm. + stratifié

Esp. 12-18-38-58 mm + laminado

Dimensioni massime: 1280mm - 4150mm - Metallo (Lunghezza max. 3050mm)

Maximum dimensions: 1280mm - 4150mm - Metal (Maximum length 3050)

Dimensions maximales : 1280mm - 4150mm - Les Métaux (Longueur maximum 3050)

Dimensiones máximas: 1.280mm - 4.150mm - Los metales (Longitud máxima 3.050)

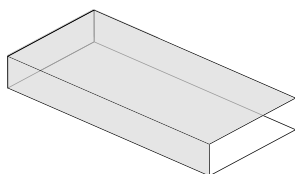

**Piano di lavoro** • Profilo anteriore in ABS • Profilo posteriore di protezione

**Worktop** • ABS front profile • Protective rear profile

**Plan de travail** • Chant avant ABS • Chant arrière protection

**Encimera** • Canto delantero ABS • Canto trasero de protección

P/R	W	U. M.
PT40-19/39	0-400	M/L.
PT65-19/39	401-650	M/L.
PT90-19/39	651-900	M/L.
PT120-19/39	901-1200	M/L.
PT128-19/39	1201-1280	M/L.

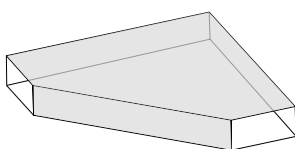

**Angolo** • Profilo anteriore in ABS • Profilo posteriore di protezione • Assemblaggio

**Corner top** • ABS front profile • Protective rear profile • Assemblages

**Plan d'angle** • Chant avant ABS • Chant arrière protection • Assemblages

**Plano de esquina** • Canto delantero ABS • Canto trasero de protección • Ensamblajes

P/R	W	U. M.
PTA90-19/39	900x900	U
PTA95-19/39	950x950	U
PTA105-19/39	1050x1050	U

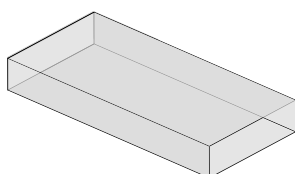

**Penisola "interno = esterno"**

Profilo anteriore e posteriore in ABS

**Double-faced worktop**

2 ABS Profiles

**Plan de travail double face**

2 Chants ABS

**Encimera doble cara**

2 cantos ABS

P/R	W	U. M.
PTDF40-19/39	0-400	M/L.
PTDF65-19/39	401-650	M/L.
PTDF90-19/39	651-900	M/L.
PTDF120-19/39	901-1200	M/L.
PSTDF 128- 19/39	1201-1280	M/L.

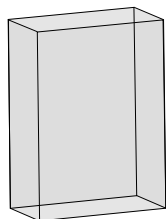

**Fianco "interno = esterno"**

Profilo anteriore e posteriore in ABS

**Double-faced side panel**

2 ABS Profiles

**Jambage double face**

2 Chants ABS

**Lateral doble cara**

2 cantos ABS Plaqués

P/R	W	U. M.
PTDF40-19/39	0-400	M/L.
PTDF65-19/39	401-650	M/L.
PTDF90-19/39	651-900	M/L.
PTDF120-19/39	901-1200	M/L.
PSTDF 128- 19/39	1201-1280	M/L.

**P/R** = Referenza Prodotto / Product Reference / Référence Produit / Referencia Producto

**W** = Profondità / Width / Profondeur / Fondo

**U.M.** = Unità di Misura / Unit of Measure / Unité de Mesure / Unidad de Medida



---



## Lavorazioni speciali

Worktop machining options

Options d'usinage plans de travail

Opciones de mecanización de encimeras

---

### Laminati HPL

HPL laminate

Stratié HPL

Laminado HPL

19-39-59 mm

---

### Laminati HPL con poro sincronizzato

HPL Laminate synchronised pores

Stratifié HPL pores synchronisés

Laminado HPL poro sincronizado

19-39 mm

---

### Laminati FENIX

FENIX Laminate

Stratié FENIX

Laminado FENIX

19-39-59 mm

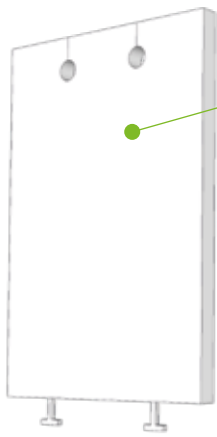

**UJ**

**ABS 3 lati + protezione inferiore + piedini**  
 3 sides ABS + bottom protection edge + feet  
 3 chants ABS + Chants de protection bas + pieds  
 3 Cantos ABS + Canto de proteccion inferior  
 Perforacion Herraje de fijacion alto Patas de ajuste inferior

**U.M. Unit**

**UPS**

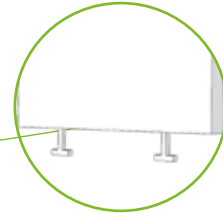

**Piedini regolabili**  
 Adjustment feet  
 Usinage des pieds  
 Solo instalacion de patas

**U.M. Unit**

**Il prezzo include la lavorazione del piano di lavoro, indicarne la posizione**

**The price includes worktop machining, please consider its positioning**

**Usinage du P.D.T compris dans le prix merci de le positionner**

**El precio incluye mecanizados, indique posicion**

**PD**

**Taglio Fem/Dx**  
 R/Fem cut  
 Déc. Plat D.  
 Corte Dcha/Hembra

**BG**

**Taglio Mas/Sx**  
 L/Male cut  
 Déc. Bout G  
 Corte lz/macho

**BD**

**Taglio Mas/Dx**  
 R/Male cut  
 Déc. Bout D.  
 Corte D/macho

**PG**

**Taglio Fem/Sx**  
 L/Fem cut  
 Déc. Plat G  
 Corte Izda Hembra

**UJ**

**U.M. Unit**

**D1**

**Taglio ang. var Dx**  
 Variable angle R cut  
 Déc. Angle variable D.  
 Corte angulo Dcho variable

**D2**

**Taglio ang. var Sx**  
 Variable angle L cut  
 Déc. Angle variable G.  
 Corte angulo Izdo variable

**D4**

**Taglio Sx**  
 L cut  
 Déc. D  
 Corte Izdo recto

**D3**

**Taglio Dx**  
 R cut  
 Déc. G  
 Corte Dcho recto

**U.M. Unit**

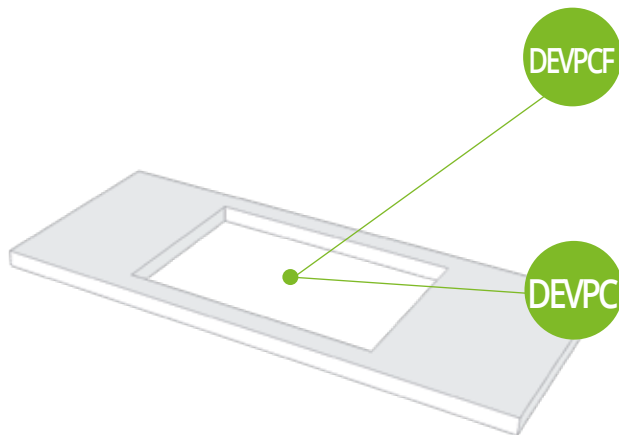

**DEVPCF** Foro livello filo top\*  
 Recessed Sink Cut\*  
 Pose à fleur plaque ou évier\*  
 Corte fregadero o placa enrasado\*

**U.M. Unit**

**DEVPC** Foro livello e piano cottura  
 Sink and Hob hole cuts  
 Coupe évier, Plaque de Cuisson  
 Corte fregadero, placa de cocción

**Raggio minimo**  
 Minimum radius / Rayon min / Radio mínimo: 5mm

**U.M. Unit**

\* Lavorazione esclusiva per laminati FENIX  
 Exclusive machining for FENIX laminates / Usinage exclusif pour stratifiés FENIX / Mecanizacion exclusiva para laminados FENIX

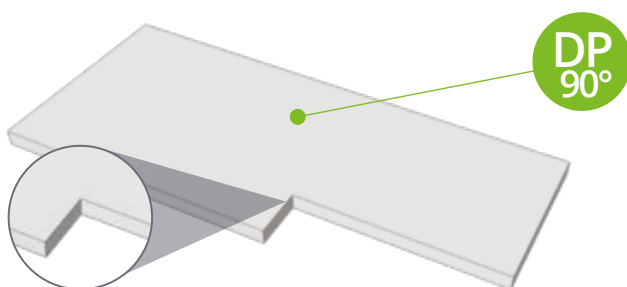

**DP 90°** Scasso pilastro a 90° + ABS  
 Corner cut 90° + ABS  
 Coupe d'angle 90° + ABS  
 Corte angular 90° canteado ABS

**U.M. Unit**

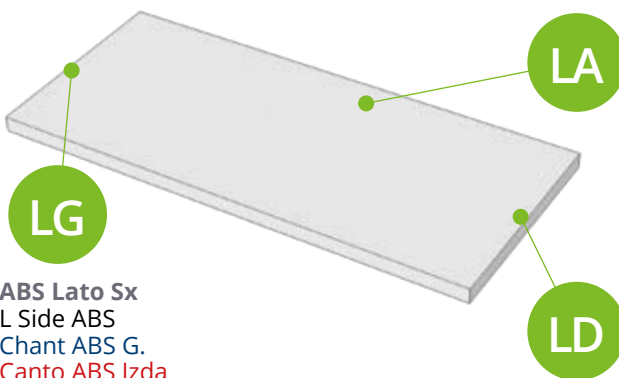

**LA** ABS Posteriore  
 Rear Side ABS  
 Chant ABS arrière  
 Canto ABS Posterior

**U.M. M/L**

**LG** ABS Lato Sx  
 L Side ABS  
 Chant ABS G.  
 Canto ABS Izda

**LD** ABS Lato Dx  
 R Side ABS  
 Chant ABS D.  
 Canto ABS Dcha

**U.M. Unit**

**Taglio Post. Sx + ABS**  
 Rear L cut + ABS S  
 Découp Arrière G. + ABS  
 Corte posterior Izdo + canto ABS

**XD**

**Taglio Post. Dx + ABS**  
 Rear R cut + ABS  
 Découp Arrière D. + ABS  
 Corte posterior Dcho + canto ABS

**XB**

**Taglio Front. Sx + ABS**  
 Front L cut + ABS  
 Découp Avant G. + ABS  
 Corte delantero Izdo + canto ABS

**XC**

**Taglio Front. Dx + ABS**  
 Front R cut + ABS  
 Découp Avant D. + ABS  
 Corte delantero Dcho + canto ABS

**XA**

**U.M. Unit**

**U.M. = Unità di Misura / Unit of Measure / Unité de Mesure / Unidad de Medida**

**Arrot. Post. Sx + ABS**  
 Rear L round cut + ABS  
 Coin arrondi arrière G. + ABS  
 Redondeo posterior Izdo + canto ABS



**Arrot. Post. Dx + ABS**  
 Rear R round cut + ABS  
 Coin arrondi arrière D. + ABS  
 Redondeo posterior Dcho + canto ABS

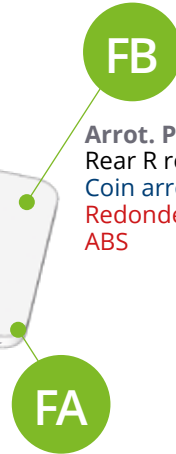

**Arrot. Front. Sx + ABS**  
 Front L round cut + ABS  
 Coin arrondi avant G. + ABS  
 Redondeo delantero Izdo + canto ABS



**Arrot. Front. Dx + ABS**  
 Front R round cut + ABS  
 Coin arrondi avant D. + ABS  
 Redondeo delantero Dcho + canto ABS

Raggio minimo / Minimum radius / Rayon min / Radio mínimo: 30mm

**U.M. Unit**

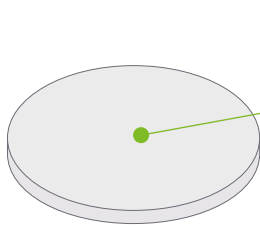

**FH**  
**Tavolo circolare + ABS**  
 Round Table + ABS  
 Table ronde + ABS  
 Masa redonda + canto ABS

**U.M. Unit**

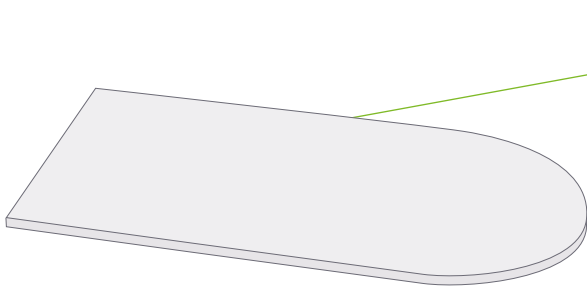

**FG**  
**Tavolo semicircolare + ABS**  
 Half round Table + ABS  
 Table demi-rond + ABS  
 Mesa semiredonda + canto ABS

**U.M. Unit**

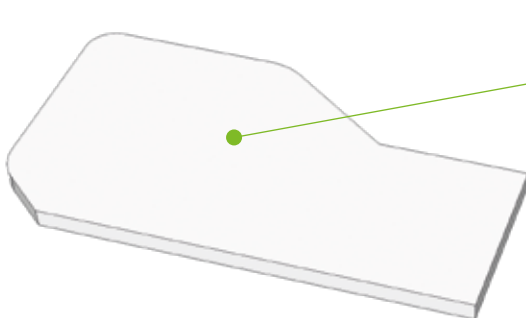

**DSFL**  
**Forma Speciale + ABS**  
 Custom Shape + ABS  
 Forme spéciale + ABS  
 Forma especial + canto ABS

**U.M. Unit**

**U.M. = Unità di Misura / Unit of Measure / Unité de Mesure / Unidad de Medida**



---

# Schienali HPL

HPL laminate wall panels • Crédences stratifié HPL • Frontal de pared laminado HPL

## 1 o 2 facce rivestite sp. 12mm (Non idrofugo) + Laminato

1 or 2 facets th. 12mm (Not waterproof) + Laminate

1 ou 2 faces ep. 12mm (Pas hydrofuge) + Stratifié

1 ó 2 caras esp. 12mm (No hidrófugo) + laminado

## Minimo fatturabile 0,15 m<sup>2</sup>

Minimum order 0,15 m<sup>2</sup> / Minimum de facturation 0,15 m<sup>2</sup> / Facturación mínima 0,15 m<sup>2</sup>

---

### Lavorazioni speciali schienali a PAG. 37

Wall panels machining options PAGE 37

Options d'usinage crédences à PG. 37

Opciones de mecanización de frontal pared a PAG. 37



### 1 Faccia decoro

1 Decorated facet / 1 Face décor / 1 Cara decorativa

Controbilanciante bianco

White counterbalanced facet / Contrebalancée Blanc / Contracara Blanca

4 profili ABS

4 ABS profiles / 4 Chants ABS plaqués / 4 Cantos ABS

PR1-13 P/R

1280x4150 MAX. DIM.

13 TH

U.M. M2

### 2 Facce decoro

2 Decorated facets / 2 Face décor / 2 Caras decorativas

4 profili ABS

4 ABS profiles / 4 Chants ABS plaqués / 4 Cantos ABS

PR2-13 P/R

1200x4150 MAX. DIM.

13 TH

U.M. M2

---

P/R = Referenza Prodotto / Product Reference / Référence Produit / Referencia Producto

MAX. DIM. = Dimensioni massime / Max dimensions / Dimension maxi / Dimensión máx

TH = Spessore / Thickness / Épaisseur / Espesor

U.M. = Unità di Misura / Unit of Measure / Unité de Mesure / Unidad de Medida

## Schienali HPL metallo

HPL laminate wall panels metal • Crédences stratifié HPL les métaux  
• Frontal de pared laminado HPL los metales

### 2 facce rivestite sp. 12mm (Non idrofugo) + Laminato

2 facets th. 12mm (Not waterproof) + Laminate

2 faces ep. 12mm (Pas hydrofuge) + Stratifié

2 caras esp. 12mm (No hidrófugo) + laminado

### Minimo fatturabile 0,15 m<sup>2</sup>

Minimum order 0,15 m<sup>2</sup> / Minimum de facturation 0,15 m<sup>2</sup> / Facturación mínima 0,15 m<sup>2</sup>

### Lunghezza massima 3050

Maximum length 3050 / Longueur maximum 3050 / Longitud máxima 3050

#### Lavorazioni speciali schienali a PAG. 37

Wall panels machining options PAGE 37

Options d'usinage crédences à PG. 37

Opciones de mecanización de frontal pared a PAG. 37



#### MAGNETIC NERO 421 PAPIER

##### 2 Facce decoro

2 Decorated facets / 2 Face décor / 2 Caras decorative

4 profili ABS

4 ABS profiles / 4 Chants ABS plaqués / 4 Cantos ABS

#### ALLUMINIO 0873 SATINATO

##### 2 Facce decoro

2 Decorated facets / 2 Face décor / 2 Caras decorative

4 profili ABS

4 ABS profiles / 4 Chants ABS plaqués / 4 Cantos ABS

PR2-13 P/R

1200x3050 MAX. DIM.

13 TH

U.M. M2

PR2-13 P/R

1280x3050 MAX. DIM.

13 TH

U.M. M2

P/R = Referenza Prodotto / Product Reference / Référence Produit / Referencia Producto

MAX. DIM. = Dimensioni massime / Max dimensions / Dimension maxi / Dimensión máx

TH = Spessore / Thickness / Épaisseur / Espesor

U.M. = Unità di Misura / Unit of Measure / Unité de Mesure / Unidad de Medida



**Topstar S.p.A.**  
Via dell'industria 2 - 61024 Mombaroccio (PU)  
Tel. +39 0721 471 222 / 223 - Fax. +39 0721 471 224  
[info@topstarpostforming.com](mailto:info@topstarpostforming.com)